

# Manuale Uso - User Manual

ISTRUZIONE INSTALLAZIONE KIT NUOVA PORTA SU DEPOSITI VECCHI  
BIN DOOR RETROFIT KIT INSTALLATION INSTRUCTIONS

Modelli/Models **B193 - B393 - D101 - D201**

## Ice Storage Bins and Transport

EN

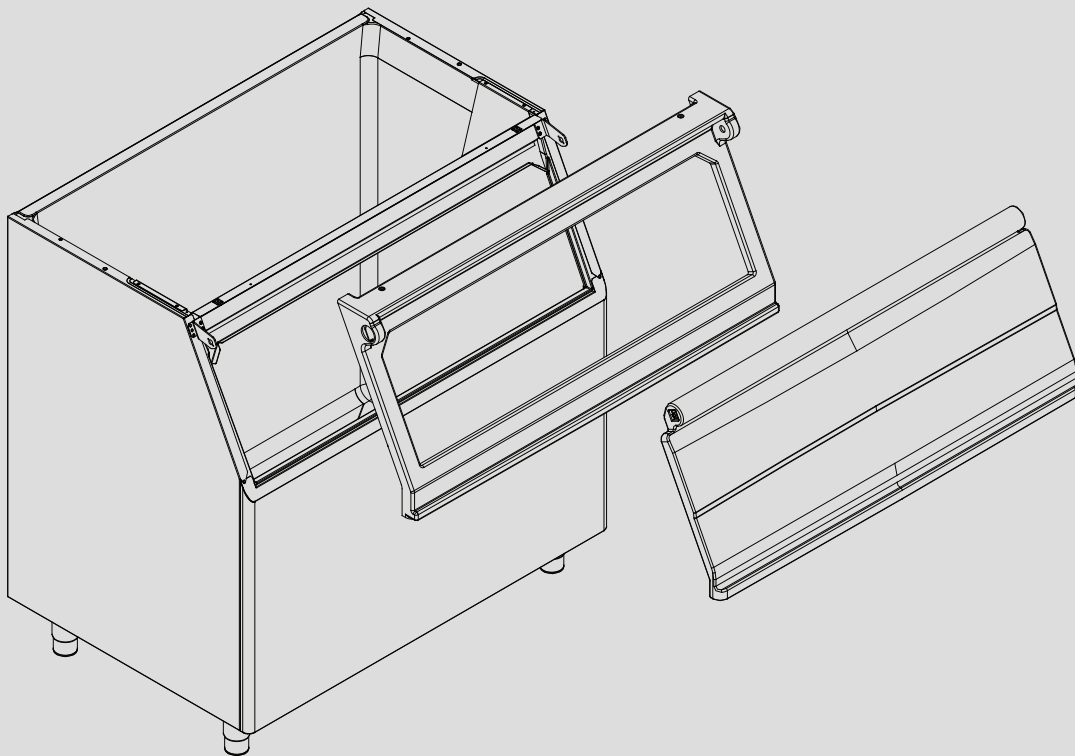

**PAGINA VUOTA - BLANK PAGE**

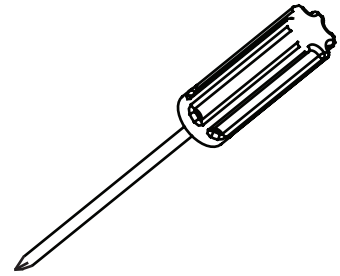
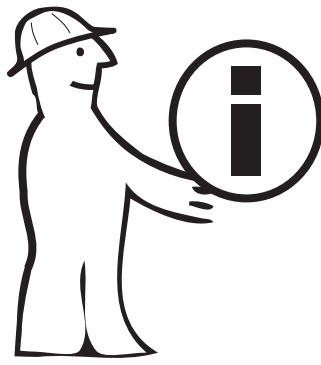

∅ 3,4 mm

- 1 Take out the machine installed on top of the storage bin
- 2 Remove the rubber gasket from both the right and left upper side of the storage bin
- 3 Unscrew and remove the two screws holding the top of the plastic bin door frame to the storage bin



- 4 Unscrew the four screws holding the two bin door hinges to the storage bin upper metal bracket and remove the bin door



- 5 Take out the plastic door frame from the storage bin cabinet
- 6 Cut/remove the old adhesive tape from the front of the storage bin cabinet and install the new one supplied in the kit in the same position of the previous one



- 7 Using a drill of 3,5 mm, drill the four rivets holding the metal bracket to the unit frame then remove it

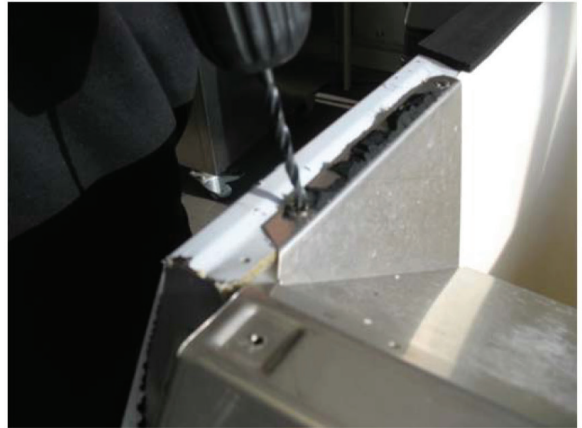

- 8 Install the new S.S. metal bracket using the rivets supplied in the kit

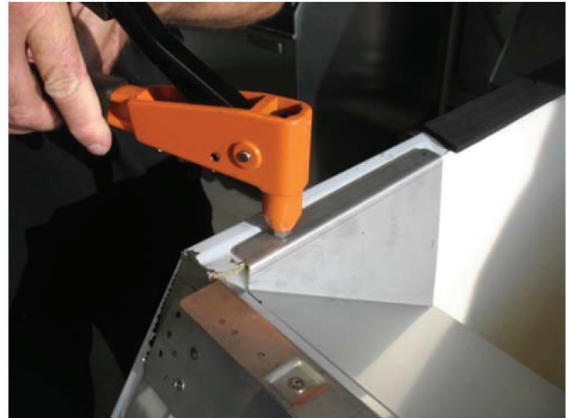

- 9 With the 3,5 mm drill, drill the four holes of the storage bin front frame so to have the four front holes of the metal bracket matching holes of the storage bin



- 10 Using the rivets supplied in the kit, secure the bin door metal bracket to the storage bin frame



11 Drill two more holes of 3,5 mm on both the bottom side of the bin door metal bracket then secure it with the rivets



14 Install the new bin door plastic frame pay attention to match the two upper holding holes



12 Install both right and left side bin door hinge brackets to the threaded holes of the bin door washer by placing in between the spacer (one per each hinge bracket)

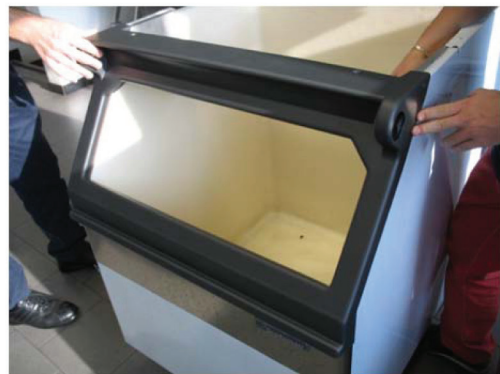

15 Secure it with supplied screws



16 Install the bin door assy between the two hinge metal brackets

17 Secure it with right and left side locker by matching the square shaft of the bin door hinge with the milled shaft of the locker

13 Install the rubber gasket on the front of the storage bin liner as shown on the pictures

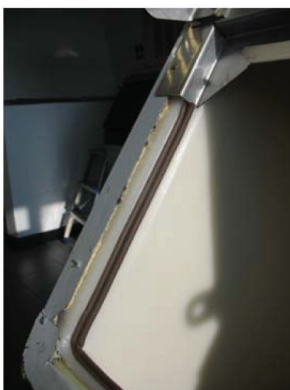

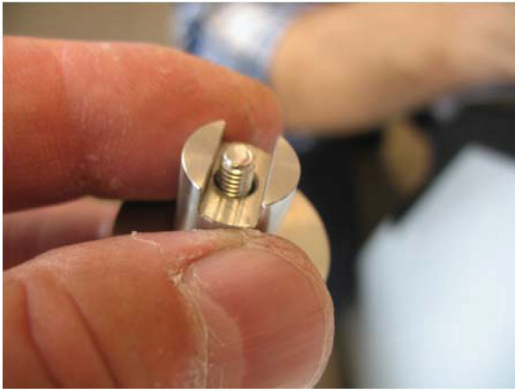

18 Secure the two lockers to the bin door hinges with the center screw



21 Secure both lockers with the two side screws



19 Move the bin door in the vertical position then.....



22 Close the bin door and re-open again (if bin door doesn't remain open in vertical position, remove the two side screws from the locker and turn it again by half turn then secure it again)

23 Install the plastic cover



20 .....turn the lockers clockwise by means of a pliers till the two side holes match the threaded holes of the hinge bracket



24 Install again the rubber gasket on top of the storage bin sides

**PAGINA VUOTA - BLANK PAGE**

